

Manual EN

Handleiding NL

Manuel FR

Anleitung DE

Manual ES

Manual SE

IT

Appendix

BlueSolar Charge Controller – LCD - USB

12V | 24V | 5A

12V | 24V | 10A

12V | 24V | 20A

1. General Information

IMPORTANT

- **Always connect the battery first, in order to allow the Controller to recognize system voltage**
- **Use a 12V (36 cells) solar array for a 12V system.**
- **Use a 24V (72 cells) solar array for a 24V system.**

The BlueSolar Charge Controller series uses Pulse Width Modulation (PWM) charge voltage control combined with a multistage charge control algorithm.

2. Features

- Three stage battery charging [bulk – absorption – float]
- Battery type: Lead-acid and LiFePO4 (with internal BMS)
- Protected against over current.
- Protected against short circuit.
- Protected against reverse polarity connection of the solar panels and/or battery.
- Low voltage load disconnect.
- Temperature protection.

3. Installation

Important note: always connect the batteries first.

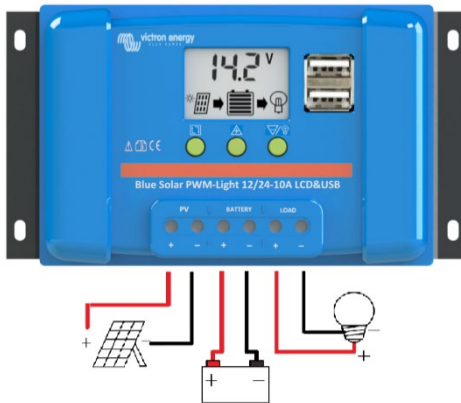

1. Connect the battery - plus and minus.
2. Connect the solar array - plus and minus.
3. Connect the load - plus and minus.

The reverse order applies when deinstalling.

An improper sequence order can damage the BlueSolar Charge Controller!

1. Make sure the battery is charged for the BlueSolar Charge Controller to recognize the battery type before first installation.
2. The battery cable should be as short as possible to minimize losses.
3. The controller is suitable only for lead-acid, and LiFePO4 batteries.
4. The BlueSolar Charge Controller is suitable only for regulating solar panels. Never connect another charging source to the charge BlueSolar Charge Controller.

4. LCD DISPLAY and SETTINGS

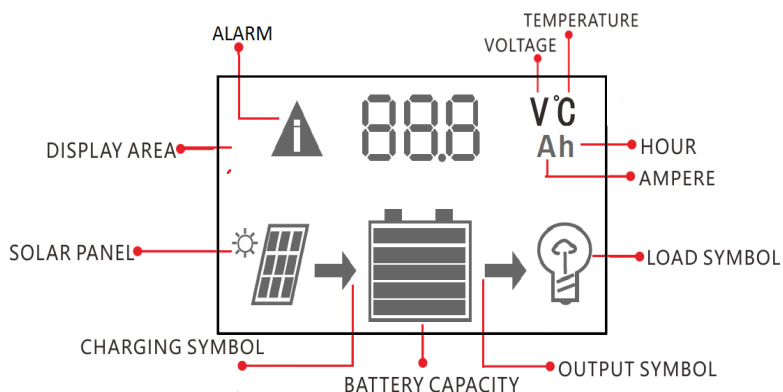

MENU: switch between different display, or to enter/exit setting by long press.



UP: press to change the settings when in setting mode.



DOWN: press to change the settings when in setting mode.
 Load on/off button when in H mode.

4.1 Monitoring and settings

Values between [] are for 24V battery settings

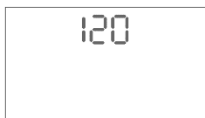

Boot Display. After connecting the battery the display shows the solar charger model and the system voltage as recognized by the solar charger.

- 105=BlueSolar Charge Controller – LCD – USB 12V|5A
- 205=BlueSolar Charge Controller – LCD – USB 24V|5A
- 110=BlueSolar Charge Controller – LCD – USB 12V|10A
- 210=BlueSolar Charge Controller – LCD – USB 24V|10A
- 120=BlueSolar Charge Controller – LCD – USB 12V|20A
- 220=BlueSolar Charge Controller – LCD – USB 24V|20A

Press MENU  to enter next display.



Main display: battery voltage, battery state of charge, charging and discharging status.

Press MENU  to enter next display.

Change settings in Main display.

Press the MENU  button for several seconds until the display flashes, you are in:



Battery type setting. See table below.

The factory setting is b01

	Battery type	Battery voltage	Absorb tion voltage	Float voltage	Low voltage disconnect factory setting	Low voltage disconnect range	Low voltage reconnect factory setting	Low voltage reconnect range
b01	LEAD-ACID [AGM]	12.0V [24V]	14.4V [28.8V]	13.7V [27.4V]	11.2V [22.4V]	10.5V-12.0V in steps of 0.1V	12.6V [25.2V]	12.0V-13.5V in steps of 0.1V
b02	LEAD-ACID [Gel]	12.0V [24V]	14.2V [28.4V]	13.7V [27.4V]	11.2V [22.4V]	10.5V-12.0V in steps of 0.1V	12.6V [25.2V]	12.0V-13.5V in steps of 0.1V
b03	LEAD-ACID [Wet]	12.0V [24V]	14.6V [29.2V]	13.7V [27.4V]	11.2V [22.4V]	10.5V-12.0V in steps of 0.1V	12.6V [25.2V]	12.0V-13.5V in steps of 0.1V
b04	12V LiFePO4*	12.8V	14.2V	13.35V	11.2V	10.5V-12.0V in steps of 0.1V	12.6V	12.0V-13.5V in steps of 0.1V
b05	24V LiFePO4*	25.6V	28.4V	26.7V	22.4V	21.0V-24.0V in steps of 0.1V	25.2V	24.0V-27.0V in steps of 0.1V

*The controllers do not have a remote on/off input. Therefore use LiFePO4 batteries with integrated BMS only (such as the Victron SuperPack batteries)

Press on the MENU  key again and you are in:

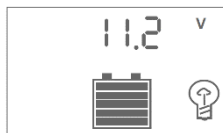

Low voltage disconnect

The factory setting is 11.2V [22.4V]

Press on the MENU  key again and you are in:

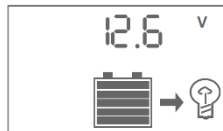

Low voltage reconnect

The factory setting is 12.6V [25.2V]



PV Voltage display: PV voltage and the state of charge of the battery.

Press MENU  to enter next display.



victron energy



Charge current display: PV to battery current and the state of charge of the battery.

Press MENU  to enter next display.



Load output settings.

The factory setting is 24h (load output always on)

Change load output settings.

Press the MENU  button for several seconds until the number flashes.



Load output setting.
See table below.

H	The load can switched on and off by the  Load on/off switch.
L	Load D2D Load will switch on at sunset and switch off at sunrise.
L01-L23	The load output will switch on after sunset and switch off after 1-23 hours.
24H	The BlueSolar Charge Controller will continuously supply power to the load.

Press MENU  to enter the next display
(**Note: the Phoenix VE.Direct inverters can be controlled by connecting to the left side connection of the remote control to the load output**)



Trigger level

When the BlueSolar Charge Controller is set to L01-L23 the solar panel voltage will be measured to decide whether it is night or day to switch the load on or off.

The factory setting is 4V.

Press MENU  to enter the next display

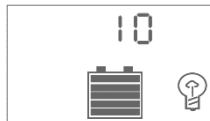

Trigger delay time

When the BlueSolar Charge Controller measures a solar panel voltage lower than the trigger value it will delay for 10 seconds and measure again to make sure night falls.

Factory setting: 10 seconds

Press MENU  to enter the next display



Short-circuit protection setting.

Some inductive or capacitive loads will trigger the short-circuit protection during start up.

Therefore the SC-protection can be disabled manually. Sc.F = OFF, Sc.n = ON. The default is ON.



Discharge current display: load current and battery capacity,
Press MENU  to enter next display.



USB Voltage display: USB voltage
5V (2A max)

Press MENU  to enter next display.



Internal controller temperature. If the controller overheats it will shut down and wait for the temperature to drop to normal level and then it will start working again.

Press MENU  to enter Main display.



5. Alarms

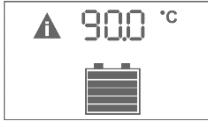

High temperature

When temp $\geq 85^{\circ}\text{C}$, the controller will enter into the first protection phase: it will lower the PV input current in order to lower the temp. There is no alarm on the LCD display.

When temp $>90^{\circ}\text{C}$, the controller will enter into the second protection phase: the PV input current will be reduced to zero, the load output will be switched off and a high temp alarm icon will show on the LCD.

After the temp has decreased to less than 82°C , BlueSolar Charge Controller will resume normal operation.

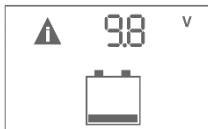

Low battery voltage

When the battery is discharged to less than the Low Voltage Disconnect (LVD) voltage, the controller will disable the load output. After over-discharge the load output will be re-enabled when the battery voltage reaches the Low Voltage Reconnect (LVR) level.



Over-current protection.

A load output over-current or short-circuit is indicated by a flashing load icon. The controller will disable the load output and try to re-enable after 30 seconds.

Shut down after 60s in case of 110%-130% load.

Shut down after 5s in case of 130%-160% load.

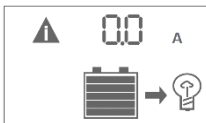

Short-circuit protection

The BlueSolar Charge Controller will switch off the load output and wait for 30s and then try to restart. User should check and remove the trouble in time.

6. Specifications

BlueSolar Charge Controller	12V 24V 5A		12V 24V 10A		12V 24V 20A	
	12V	24V	12V	24V	12V	24V
Battery Voltage	12/24V Auto Select					
Charge & Load Current	5A		10A		20A	
Charge mode	PWM, Time and Lighting Control					
Automatic load disconnect	Yes					
Maximum solar array voltage	55V					
Solar voltage range	15-28V [30-55V] ²					
Self-consumption	<10mA					
Protections	Reverse polarity connection of the solar panels. Reverse polarity connection of the battery. Low voltage disconnect. 130% load: Shuts down after 60sec. 160% load: Shuts down after 5sec. Short circuit: immediate shut down. Over-temperature protection.					
Solar Panel						
Recommended solar panel array	36cell [72cell] ²					
Max Solar Input Power	60W	120W	120W	240W	240W	480W
USB outputs						
Voltage	5V					
Current	2A (total from 2 USB outputs)					
Default settings						
Absorption charge (b01) ¹	14.4V [28.8V] ²					
Float charge (b01) ¹	13.7V [27.4V] ²					
Load disconnect (b01) ¹	11.2V [22.4V] ²					
Load reconnect (b01) ¹	12.6V [25.2V] ²					
Enclosure						
Terminal size	6mm ² / AWG10					
Weight	150gr					
Dimension (h x w x d)	96 x 169 x 36 mm					
Mounting	Vertical wall mount, indoor only					
Humidity (non condensing)	Max. 95%					
Operating temperature	-35°C to +60°C (full load)					
Cooling	Natural convection					
Protection class	IP20					
Standards						
Safety	EN60335-1, IEC62109-1					
EMC	EN61000-6-1, EN61000-6-3					

¹ See also 3.1 Battery type setting.

² [V] values for 24V system.



1. Algemene Informatie

BELANGRIJK

- **Altijd eerst de accu aansluiten, teneinde de Besturingseenheid het herkennen van het spanningsstelsel mogelijk te maken**
- **Gebruik een 12V (36 cellen) zonnepaneel voor een 12V stelsel.**
- **Gebruik een 24V (72 cellen) zonnepaneel voor een 24V stelsel.**

De BlueSolar Laadregelaar serie maakt gebruik van pulsbreedtemodulatie (PWM) laadspanningsregeling gecombineerd met een meertraps laad regelalgoritme.

2. Kenmerken

- Acculaden in drie fasen [bulk - absorptie - float]
- Accutype: Loodzuur en LiFePO4 (met interne BMS)
- Beschermd tegen overstroom.
- Beschermd tegen kortsluiting.
- Beschermd tegen omgekeerde polariteitsverbinding van de zonnepanelen en/of accu.
- Ontkoppeling van lage spanning.
- Temperatuurbescherming.

3. Installatie

Belangrijke kennisgeving: altijd eerst de accu's aansluiten.



1. Sluit de accu aan - plus- en minteken.
2. Sluit het zonnepaneel aan - plus- en minteken.
3. Sluit de stroom aan - plus- en minteken.

De omgekeerde volgorde is van toepassing bij het demonteren.

Een onjuiste volgorde kan de BlueSolar Laadregelaar beschadigen!

1. Controleer of de accu voor de BlueSolar Laadregelaar is opgeladen, om het accutype te herkennen vóór de eerste installatie.
2. De accukabel moet zo kort mogelijk zijn om wegvloeiing te minimaliseren.
3. De regelaar is alleen geschikt voor Loodzuur en LiFePO4 accu's.
4. De BlueSolar Laadregelaar is alleen geschikt voor het regelen van zonnemodules. Nooit een andere laadbron op de lading van de BlueSolar Laadregelaar aansluiten.

4. LCD-SCHERM en INSTELLINGEN

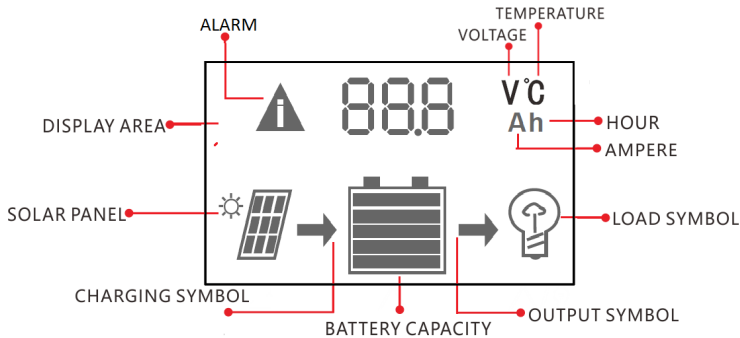

MENU: schakelen tussen verschillende weergaven of om de instelling te openen/sluiten door lang in te drukken.



OMHOOG: indrukken om de instellingen te wijzigen in de instellingsmodus.



OMLAAG: indrukken om de instellingen te wijzigen in de instellingsmodus. Laden aan-/uitknop wanneer in H-modus.

4.1 Monitoring en instellingen

Waarden tussen [] zijn voor 24V-accu instellingen



Opstartscherm. Na het aansluiten van de accu zal het display het model zonnelader en de systeemspanning zoals herkend door de zonnelader weergeven.

105 = BlueSolar Laadregelaar - LCD - USB 12V | 5A

205 = BlueSolar Laadregelaar - LCD - USB 24V | 5A

110 = BlueSolar Laadregelaar - LCD - USB 12V | 10A

210 = BlueSolar Laadregelaar - LCD - USB 24V | 10A

120 = BlueSolar Laadregelaar - LCD - USB 12V | 20A

220 = BlueSolar Laadregelaar - LCD - USB 24V | 20A

Druk op ME  om naar het volgende scherm te gaan.



Hoofdscherm: accu spanning, accustatus van opladen, laad- en ontladstatus.

Druk op MENU  om naar het volgende scherm te gaan.

Wijzig de instellingen in het Hoofdscherm.

Druk op gedurende enkele seconden op de MENU  knop totdat het display knippert, u bevindt zich in:



Instelling accutype.

Zie onderstaande tabel.

De fabrieksinstelling is b01

	Accutype	Accu spanning	Absorptievermogen	Float-lading	Fabrieksinstelling voor ont koppeling bij laag spanning	Laagspanning bereik ont koppelen	Fabrieksinstelling voor ont koppeling verbinden op laag spanning	Laagspanning bereik opnieuw koppelen
b01	LEAD-ACID [AGM]	12.0V [24V]	14.4V [28.8V]	13.7V [27.4V]	11.2V [22.4V]	10.5V-12.0V in steps of 0.1V	12.6V [25.2V]	12.0V-13.5V in steps of 0.1V
b02	LEAD-ACID [Gel]	12.0V [24V]	14.2V [28.4V]	13.7V [27.4V]	11.2V [22.4V]	10.5V-12.0V in steps of 0.1V	12.6V [25.2V]	12.0V-13.5V in steps of 0.1V
b03	LEAD-ACID [Wet]	12.0V [24V]	14.6V [29.2V]	13.7V [27.4V]	11.2V [22.4V]	10.5V-12.0V in steps of 0.1V	12.6V [25.2V]	12.0V-13.5V in steps of 0.1V
b04	12V LiFePO4	12.8V	14.2V	13.35V	11.2V	10.5V-12.0V in steps of 0.1V	12.6V	12.0V-13.5V in steps of 0.1V
b05	24V LiFePO4	25.6V	28.4V	26.7V	22.4V	21.0V-24.0V in steps of 0.1V	25.2V	24.0V-27.0V in steps of 0.1V

* De regelaars hebben geen externe aan/uit-ingang. Gebruik daarom LiFePO4-batterijen met alleen geïntegreerd BMS (zoals de Victron SuperPack-batterijen)

Druk op het MENU  toets opnieuw en u bevindt zich in:



Laagspanning ont koppelen

De fabrieksinstelling is 11,2V [22,4V]

Druk op het MENU  toets opnieuw en u bevindt zich in:



Laagspanning opnieuw aansluiten

De fabrieksinstelling is 12,6V [25,2V]

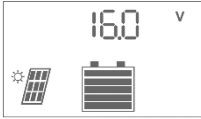

PV-spenningsdisplay: PV-spanning en de ladingstoestand van de accu.

Druk op MENU  om naar het volgende scherm te gaan.



Laadstroomdisplay: PV naar accustroom en laadtoestand van de accu.

Druk op MENU  om naar het volgende scherm te gaan.



Laad de uitgang instellingen.

De fabrieksinstelling is 24 uur (laaduitgang altijd aan)

Wijzig de instellingen voor de laaduitgang.

Druk enkele seconden op de MENU  knop totdat het nummer knippert.



Laaduitgang instelling.

Zie onderstaande tabel.

H	De lading kan worden in- en uitgeschakeld  door de Laad aan-/uitschakelaar.
L	Laad D2D Het laden schakelt in bij zonsondergang en schakelt uit bij zonsopgang.
L01-L23	De laaduitgang wordt na zonsondergang ingeschakeld en schakelt na 1-23 uur uit.
24H	De BlueSolar Laadregelaar levert continu stroom aan de lading.

Druk op MENU  om naar het volgende scherm te openen. (Opmerking: de Phoenix VE.Direct-omvormers kunnen worden bediend door verbinding te maken met de linkerkant van de afstandsbediening met de belastingsuitgang)



Activeringsniveau

Wanneer de laadregelaar is ingesteld op L01-L23, wordt de spanning van het zonnepaneel gemeten om te bepalen of het nacht of dag is, teneinde het laden in of uit te schakelen.

De fabrieksinstelling is 4V.

Druk op MENU  om naar het volgende scherm te openen.



Activering Vertragingstijd

Wanneer de laadregelaar een spanning van het zonnepaneel meet die lager is dan de triggerwaarde, wordt deze 10 seconden vertraagd en opnieuw gemeten om te zorgen dat het 's nachts inschakelt.

Fabriekinstelling: 10 seconden

Druk op MENU  om naar het volgende scherm te openen.



Kortsluitbeveiligingsinstelling.

Sommige inductieve of capacitieve ladingen activeren de kortsluitbeveiliging tijdens het opstarten. Daarom kan de SC-bescherming handmatig worden uitgeschakeld. Sc.F = UIT, Sc.n = AAN. De standaardinstelling is INGESCHAKELD.



Ontlaadstroom weergave: laadstroom en accucapaciteit,
Druk op MENU  om naar het volgende scherm te gaan.



USB-spanningsdisplay: USB-spanning
5V (2A max)

Druk op MENU  om naar het volgende scherm te gaan.



Interne temperatuurregelaar. Indien de laadregelaar tijdens het heet worden, wordt deze uitgeschakeld en wacht tot de temperatuur weer is gedaald tot het normale niveau en zal deze weer gaan werken.

Druk op MENU  om het Hoofdscherm te openen.

5. Alarmen



Hoge temperatuur

Bij temperaturen ≥ 85 °C zal de BlueSolar Laadregelaar de eerste beveiligingsfase openen: de PV-ingangsstroom wordt verlaagd, teneinde de temperatuur te verlagen. Er wordt geen alarm op het LCD-scherm weergegeven.

Bij een temp > 90 °C zal de BlueSolar Laadregelaar de tweede beschermingsfase openen: de PV-ingangsstroom wordt tot nul teruggebracht, de laaduitgang wordt uitgeschakeld en een alarm voor een hoog temperatuuralarm verschijnt op het LCD-scherm. Nadat de temperatuur is gedaald tot minder dan 82 °C, hervat de BlueSolar Laadregelaar de normale werking.

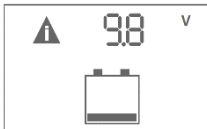

Lage accuspanning

Wanneer de batterij wordt ontladen tot minder dan de Low Voltage Disconnect (LVD) -spanning, schakelt de laadregelaar de laaduitgang uit. Na overstroom wordt de laaduitgang opnieuw ingeschakeld wanneer de accuspanning het LVR-niveau (Low Voltage Reconnect) bereikt.

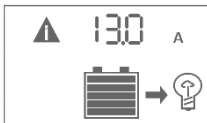

Overstroombeveiliging.

Een overstroom van de laaduitgang of kortsluiting wordt aangegeven door een knipperend laadpictogram. De laadregelaar schakelt de laaduitgang uit en probeert na 30 seconden opnieuw in te schakelen. Uitschakelen na 60s bij 110% -130% lading. Uitschakelen na 5 seconden bij 130% tot 160% lading.

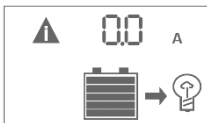

Kortsluitingsbeveiliging

Dit scherm betekent dat er een beveiliging tegen kortsluiting optreedt. De laadregelaar schakelt de laaduitgang uit, wacht 30 seconden en probeert vervolgens opnieuw op te starten. De gebruiker zou de problemen op tijd moeten controleren en verwijderen.

6. Specificaties

BlueSolar Laadregelaar	12V 24V 5A		12V 24V 10A		12V 24V 20A	
	12V	24V	12V	24V	12V	24V
Accuspanning	12/24V Auto Selecteer					
Laden & Laadstroom	5A		10A		20A	
Laadmodus	PWM, Tijd- en Lichtregeling					
Automatische laadafsluiting	Ja					
Maximale zonne-energiespanning	55V					
Zonnespanningsbereik	15-28V [30-55V] ²					
Eigen verbruik	<10mA					
Beveiligingen	Omgekeerde polariteitsverbinding van de zonnepanelen. Omgekeerde polariteitsverbinding van de accu. Ontkoppeling met lage spanning. 130% lading: Schakelt uit na 60 sec. 160% lading: Schakelt uit na 5 seconden. Kortsluiting: onmiddellijk uitgeschakeld. Overtemperatuurbeveiliging.					
Zonnepaneel						
Aanbevolen zonnepaneelserie	36 cellen [72 cellen] ²					
Max. ingangsvermogen voor zonne-energie	60W	120W	120W	240W	240W	480W
USB-uitgangen						
Spanning	5V					
Spanning	2A (totaal van 2 USB-uitgangen)					
Standaard instellingen						
Absorptie-lading (b01)¹	14,4V [28,8V] ²					
Float-lading (b01)¹	13,7V [27,4V] ²					
Ontkoppel de belasting (b01)¹	11,2V [22,4V] ²					
Lading opnieuw verbinden (b01)¹	12,6V [25,2V] ²					
Behuizing						
Terminal grootte	6mm ² / AWG10					
Gewicht	150gr					
Afmetingen (h x b x d)	96 x 169 x 36 mm					
Montage	Verticale wandmontage, alleen binnenshuis					
Vochtigheid (zonder condensatie)	Max. 95%					
Bedrijfstemperatuur	-35°C tot + 60°C (volledige lading)					
Koeling	Natuurlijke convectie					
Beschermingsklasse	IP20					
Normen						
Veiligheid	EN60335-1, IEC62109-1					
EMC	EN61000-6-1, EN61000-6-3					

¹ Zie ook 3.1 Instelling accutype.

² [V] waarden voor 24V-systeem



1. Consignes générales

IMPORTANT

- **Toujours connecter les batteries en premier.**
- **Pour un système de batterie de 12 V, n'utilisez que le dispositif de panneaux solaires de 12 V (36 cellules).**
- **Pour un système de batterie de 24 V, n'utilisez que le dispositif de panneaux solaires de 24 V (72 cellules).**

La gamme de contrôleurs de charge BlueSolar utilise le contrôle de tension de charge « Pulse Width Modulation » (PWM - Modulation de largeur d'impulsions) allié à un algorithme de contrôle de charge en plusieurs étapes.

2. Fonctions

- Trois étapes de charge de batterie (Bulk – absorption – Float).
- Type de batterie : au plomb et LiFePO4 (avec BMS interne)
- Protection contre la surintensité.
- Protection contre les courts-circuits.
- Protection contre la connexion en polarité inversée des panneaux solaires et/ou de la batterie
- Déconnexion de la charge en cas de tension réduite.
- Protection relative à la température.

3. Installation

Remarque importante : toujours connecter les batteries en premier.



1. Connectez la batterie – pôle positif et négatif.
2. Connectez le champ de panneaux solaires – pôle positif et négatif.
3. Connectez la charge consommatrice – pôle positif et négatif.

Pour désinstaller, veuillez suivre les étapes en sens inverse.

Inverser l'ordre de la séquence peut endommager le contrôleur de charge BlueSolar !

1. Assurez-vous que votre batterie est chargée afin que le contrôleur de charge BlueSolar reconnaisse le type de batterie avant la première installation.
2. Le câble de batterie doit être le plus court possible pour réduire les pertes.
3. Le contrôleur n'est adapté que pour des batteries au plomb et LiFePO4.
4. Le contrôleur de charge BlueSolar n'est adapté que pour régler des modules solaires.
Ne jamais connecter une autre source de charge au contrôleur de charge BlueSolar.

4. ÉCRAN LCD et PARAMÈTRES

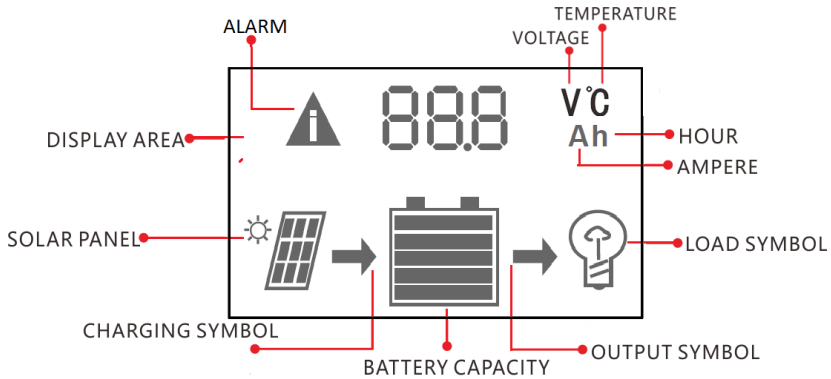

MENU : pour passer d'un écran à l'autre ou pour entrer/quitter la configuration en maintenant le bouton appuyé.



UP : appuyez pour modifier les paramètres lorsque vous êtes en mode Configuration.



DOWN : appuyez pour modifier les paramètres lorsque vous êtes en mode Configuration.

Bouton de démarrage/arrêt de charge en mode H.

4.1 Supervision et paramètres

Les valeurs entre [] correspondent à des paramètres de batterie de 24 V.





Initialiser l'écran. Après avoir connecté la batterie, l'écran indique le modèle du chargeur solaire et la tension du système reconnu par le chargeur solaire.

105=Contrôleur de charge BlueSolar – LCD – USB 12 V|5 A
 205=Contrôleur de charge BlueSolar – LCD – USB 24 V|5 A
 110=Contrôleur de charge BlueSolar – LCD – USB 12 V|10 A
 210=Contrôleur de charge BlueSolar – LCD – USB 24 V|10 A
 120=Contrôleur de charge BlueSolar – LCD – USB 12 V|20 A
 220=Contrôleur de charge BlueSolar – LCD – USB 24 V|20 A
 Appuyez sur MENU  pour passer à l'écran suivant.



Écran principal : tension de batterie, état de charge de la batterie, statut du processus de charge et décharge.

Appuyez sur MENU  pour passer à l'écran suivant.

Modifier les paramètres sur l'écran principal. Appuyez sur le bouton MENU  pendant plusieurs secondes jusqu'à ce que l'écran clignote, vous êtes :



Configuration du type de batterie.
Voir le tableau ci-dessous.

Le réglage standard est b01.

	Type de batterie	Tension de la batterie	Tension d'absorption	Tension Float	Tension faible Configuration d'usine pour la déconnexion	Tension faible Plage de déconnexion	Tension faible Configuration d'usine pour la reconnexion	Plage de reconnexion en cas de tension faible
b01	PLOMB [AGM]	12,0 V [24 V]	14,4 V [28,8 V]	13,7 V [27,4 V]	11,2 V [22,4 V]	10,5 V-12,0 V par étapes de 0,1 V	12,6 V [25,2 V]	12,0 V-13,5 V par étapes de 0,1 V
b02	PLOMB [À électrolyte gélifié]	12,0 V [24 V]	14,2 V [28,4 V]	13,7 V [27,4 V]	11,2 V [22,4 V]	10,5 V-12,0 V par étapes de 0,1 V	12,6 V [25,2 V]	12,0 V-13,5 V par étapes de 0,1 V
b03	PLOMB [À électrolyte]	12,0 V [24 V]	14,6 V [29,2 V]	13,7 V [27,4 V]	11,2 V [22,4 V]	10,5 V-12,0 V par étapes de 0,1 V	12,6 V [25,2 V]	12,0 V-13,5 V par étapes de 0,1 V
b04	12 V LiFePO4	12,8 V	14,2 V	13,35 V	11,2 V	10,5 V-12,0 V par étapes de 0,1 V	12,6 V	12,0 V-13,5 V par étapes de 0,1 V
b05	24 V LiFePO4	25.6 V	28.4 V	26.7 V	22.4 V	21.0 V-24.0 V par étapes de 0.1 V	25.2 V	24.0 V-27.0 V par étapes de 0.1 V

*Les contrôleurs ne disposent pas d'une entrée d'allumage/arrêt à distance. C'est pourquoi, il ne faut utiliser que des batteries LiFePO4 avec un BMS intégré (telles que les batteries SuperPack Victron).

Appuyez à nouveau sur la touche MENU  pour arriver dans :



Déconnexion en cas de tension réduite :
Le réglage standard est 11,2 V [22,4 V]

Appuyez à nouveau sur la touche MENU  pour arriver dans :



Reconnexion en cas de tension faible
Le réglage standard est 12,6 V [25,2 V]



victron energy



Écran de tension PV : Tension PV et état de charge de la batterie.

Appuyez sur MENU  pour passer à l'écran suivant.



Écran de courant de charge : Courant de batterie au PV et état de charge de la batterie.

Appuyez sur MENU  pour passer à l'écran suivant.



Paramètres de sortie de la charge

La configuration standard est 24 h (sortie de la charge toujours ouverte).

Modifier les paramètres de sortie de la charge.

Appuyez sur le bouton MENU  pendant plusieurs secondes jusqu'à ce que le nombre clignote.

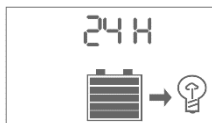

Paramètres de sortie de charge.

Voir le tableau ci-dessous.

H	Le chargeur de batterie peut être allumé et éteint avec l'interrupteur d'allumage/arrêt  .
L	Charge D2D La charge consommatrice s'allumera au coucher du soleil et s'éteindra au lever du soleil.
L01-L23	La sortie de la charge consommatrice s'allumera après le coucher du soleil et s'éteindra après 1-23 heures.
24H	Le contrôleur de charge BlueSolar alimentera la charge en continu.

Appuyez sur MENU  pour passer à l'écran suivant.

(Remarque : les convertisseurs Phoenix VE.Direct peuvent être contrôlés en raccordant la connexion de gauche du contrôle à



Niveau de déclenchement

Lorsque le contrôleur de charge est configuré sur L01-L23, la tension des panneaux solaires sera mesurée pour décider s'il fait nuit ou s'il fait jour pour allumer ou éteindre la charge.

Le réglage standard est 4 V.

distance à la sortie de la charge).

Appuyez sur MENU  pour passer à l'écran suivant.

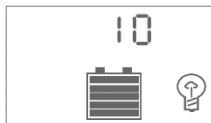

Temps de retard du déclenchement

Lorsque le contrôleur de charge mesure une tension sur les panneaux solaires inférieure à la valeur de déclenchement, il attendra 10 secondes et mesurera à nouveau pour s'assurer que la nuit tombe.

Configuration d'usine : 10 secondes

Configuration de la protection contre les courts-circuits.

Certaines charges inductives ou capacitives déclencheront la protection contre les courts-circuits en démarrant. Cependant, la protection contre les courts-circuits peut être désactivée manuellement. Sc.F = OFF, Sc.n = ON. Par défaut, le paramètre standard est sur ON.

Appuyez sur MENU  pour passer à l'écran suivant.



Écran du courant de décharge : courant de charge et capacité de batterie.

Appuyez sur MENU  pour passer à l'écran suivant.



Écran de tension USB : Tension USB 5 V (2 A max)

Appuyez sur MENU  pour passer à l'écran suivant.



Température du contrôleur interne. Si le contrôleur de charge chauffe durant son fonctionnement, il s'éteindra et attendra que la température baisse à un niveau normal avant de recommencer à fonctionner.

Appuyez sur MENU  pour aller à l'écran principal.



victron energy

5. Alarmes



Température élevée

Si la temp. est $\geq 85^{\circ}\text{C}$, le contrôleur de charge BlueSolar passera à la première phase de protection : il réduira le courant d'entrée PV afin d'abaisser la température. Aucune alarme n'apparaît sur l'écran LCD.

Si la temp. est $>90^{\circ}\text{C}$, le contrôleur de charge passera à la deuxième phase de protection : le courant d'entrée PV sera réduit à zéro, la sortie de charge s'éteindra, et une icône d'alarme de température élevée apparaîtra sur l'écran LCD. Dès que la température passe en dessous de 82°C , le contrôleur de charge BlueSolar reprendra son fonctionnement normal.

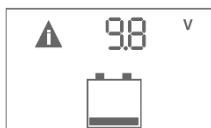

Tension de batterie faible

Lorsque la batterie est déchargée en dessous du niveau de déconnexion en cas de tension faible (LVD), le contrôleur de charge BlueSolar désactivera la sortie de charge. Après une décharge excessive, la sortie de charge sera réactivée si la tension de la batterie atteint le niveau de reconnexion en cas de tension faible (LVR).



Protection contre la surintensité.

Une surintensité ou un court-circuit sur une sortie de charge est signalée par l'icône de la charge qui clignote. Le contrôleur de charge BlueSolar désactivera la sortie de la charge et essaiera de la réactiver au bout de 30 secondes. Arrêt au bout de 60 s en cas de charge à 110-130 %. Arrêt au bout de 5 s en cas de charge à 130-160 %.

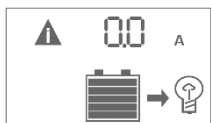

Protection contre les courts-circuits

Cet écran signifie qu'une protection contre les courts-circuits s'est déclenchée. Le contrôleur de charge BlueSolar éteindra la sortie de la charge et attendra pendant 30 secondes, puis il essaiera de redémarrer à nouveau. L'utilisateur devra vérifier et résoudre la panne à temps.

6. Caractéristiques

Contrôleur de charge BlueSolar	12 V 24 V 5 A		12 V 24 V 10 A		12 V 24 V 20 A	
	12 V	24 V	12 V	24 V	12 V	24 V
Tension de batterie	Sélection automatique 12/24 V					
Charge et courant de la charge	5 A		10 A		20 A	
Mode de charge	PWM, Contrôle de l'éclairage et du temps					
Déconnexion de charge automatique	Oui					
Tension maximale du champ de panneaux solaires	55 V					
Plage de tension solaire	15-28 V [30-55 V] ²					
Autoconsommation	< 10mA					
Protections	Connexion en polarité inversé des panneaux solaires. Connexion en polarité inversé de la batterie. Déconnexion en cas de tension réduite. Charge à 130 % : arrêt au bout de 60 s. Charge à 160 % : arrêt au bout de 5 s. Court-circuit : arrêt immédiat. Protection contre la surchauffe.					
Panneau solaire						
Champ de panneaux solaires recommandé	36 cellules [72 cellules] ²					
Puissance d'entrée solaire max.	60 W	120 W	120 W	240 W	240 W	480 W
Sorties USB						
Tension	5 V					
Courant	2 A (total depuis 2 sorties USB)					
Paramètres par défaut						
Charge d'absorption (b01) ¹	14,4 V [28,8 V] ²					
Charge Float (b01) ¹	13,7 V [27,4 V] ²					
Déconnexion de charge (b01) ¹	11,2 V [22,4 V] ²					
Reconnexion de charge (b01) ¹	12,6 V [25,2 V] ²					
Boîtier						
Taille de la borne	6mm ² / AWG10					
Poids	150 g					
Dimension (h x l x p)	96 x 169 x 36 mm					
Montage	Montage mural vertical – seulement à l'intérieur					
Humidité (sans condensation)	Max. 95%					
Température d'exploitation	-35°C à +60°C (charge pleine)					
Refroidissement	Convection naturelle					
Classe de protection	IP20					
Normes						
Sécurité	EN60335-1, IEC62109-1					
EMC	EN61000-6-1, EN61000-6-3					



1. Allgemeine Informationen

EN

NL

FR

DE

ES

SV

IT

Appendix

WICHTIGER HINWEIS

- **Schließen Sie die Batterie immer zuerst an, damit der Regler die Systemspannung erkennen kann.**
- **Verwenden Sie eine Solaranlage mit 12 V (36 Zellen) für ein 12 V System.**
- **Verwenden Sie eine Solaranlage mit 24 V (72 Zellen) für ein 24 V System.**

Die Serie der BlueSolar Lade-Regler verwendet zur Ladespannungsregelung eine Pulsweitenmodulation (PWM) kombiniert mit einem mehrstufigen Lade-Regel-Algorithmus.

2. Funktionen

- Ladung der Batterie in drei Stufen [Konstantstrom, Konstantspannung, Ladeerhaltung].
- Batterietyp: Blei-SÄURE und LiFePO4 (mit integriertem BMS)
- Schutz vor Überstrom.
- Kurzschluss-Schutz.
- Verpolungsschutz für Solarmodule und/oder Batterie.
- Abschalten der Last bei geringer Spannung.
- Temperaturschutz.

3. Installation

Wichtiger Hinweis: Schließen Sie immer zuerst die Batterien

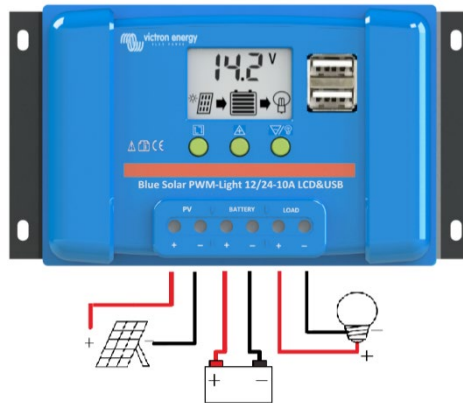

1. Batterie anschließen - Plus und Minus.
2. Solaranlage anschließen - Plus und Minus.
3. Last anschließen - Plus und Minus.

Beim Deinstallieren umgekehrt vorgehen.

Bei Nichteinhaltung der richtigen Abfolge kann der BlueSolar Lade-Regler beschädigt werden.

1. Achten Sie darauf, dass Ihre Batterie vor der Erstinstallation geladen ist, damit der BlueSolar Lade-Regler den Batterietyp erkennen kann.
2. Das Batteriekabel sollte so kurz wie möglich sein, um Kabelverluste zu minimieren.
3. Der Regler ist nur für Blei-Säure und LiFePO4-Batterien geeignet.
4. Der BlueSolar Lade-Regler ist nur zur Regelung von Solarmodulen geeignet. Schließen Sie nie eine andere Ladequelle an den BlueSolar Lade-Regler an.

4. LCD- Display und Einstellungen

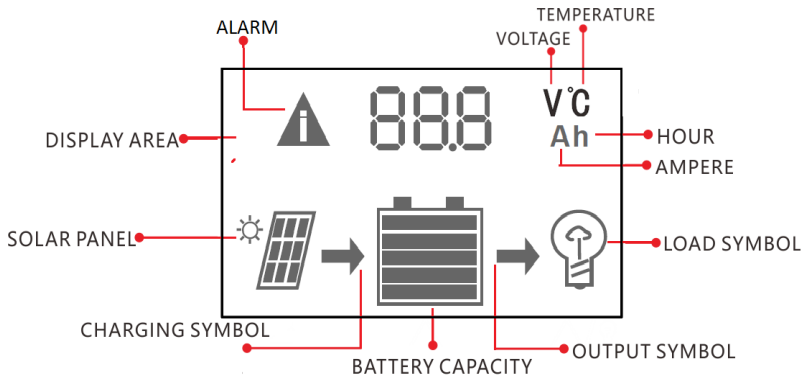

MENÜ : Zwischen verschiedenen Anzeigen hin- und herschalten oder Aufrufen/Verlassen der Einstellungen durch anhaltendes Drücken.



HOCH: im Einstellungsmodus lassen sich damit die Einstellungen ändern.



RUNTER: im Einstellungsmodus lassen sich damit die Einstellungen ändern.

Taste Last ein/aus im H-Modus

4.1 Überwachung und Einstellungen

Die Werte zwischen [] sind für 24 V-Batterieeinstellungen.

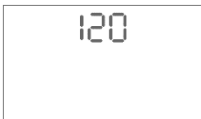

Start-Bildschirm Nach Anschließen der Batterie wird auf dem Bildschirm das Modell des Solar-Ladegeräts und die durch das Solar-Ladegerät erkannte Systemspannung angezeigt.

105=BlueSolar Lade-Regler – LCD – USB 12 V|5 A

205=BlueSolar Lade-Regler – LCD – USB 24 V|5 A

110=BlueSolar Lade-Regler – LCD – USB 12 V|10 A

210=BlueSolar Lade-Regler – LCD – USB 24 V|10 A

120=BlueSolar Lade-Regler – LCD – USB 12 V|20 A

220=BlueSolar Lade-Regler – LCD – USB 24 V|20 A

Durch Betätigen der Taste MENU  gelangen Sie zum nächsten Bildschirm.



Hauptbildschirm: Batteriespannung, Ladezustand der Batterie, Lade- und Entladestatus.

Durch Betätigen der Taste MENU  gelangen Sie zum nächsten Bildschirm.

Änderung der Einstellungen im Hauptanzeigebildschirm

Halten Sie die Taste MENU  einige Sekunden lang gedrückt, bis die Bildschirmanzeige, in der Sie sich gerade befinden, zu blinken beginnt:



Einstellung des Batterietyps:
Siehe Tabelle unten.

Die Werkseinstellung ist b01.

	Batterietyp	Battery voltage (Batteriespannung)	Absorption voltage (Konstantspannung)	Float voltage (Erhaltungsspannung)	Low voltage (Niedrige Spannung) Werkseinstellungen für Abschaltbefehl	Low voltage (Niedrige Spannung) Bereich zum Abschalten	Low voltage (Niedrige Spannung) Werkseinstellungen für Befehl zum erneuten Einschalten	Bereich zum erneuten Einschalten nach niedriger Spannung
b01	BLEI-SÄURE [AGM]	12,0 V [24 V]	14,4V [28,8 V]	13,7 V [27,4 V]	11,2 V [22,4 V]	10,5 V-12,0 V in Schritten von 0,1 V	12,6 V [25,2 V]	12,0 V-13,5 V in Schritten von 0,1 V
b02	BLEI-SÄURE [Gel]	12,0 V [24 V]	14,2 V [28,4 V]	13,7 V [27,4 V]	11,2 V [22,4 V]	10,5 V-12,0 V in Schritten von 0,1 V	12,6 V [25,2 V]	12,0V-13,5V in Schritten von 0,1 V
b03	BLEI-SÄURE [Nass]	12,0 V [24 V]	14,6 V [29,2 V]	13,7 V [27,4 V]	11,2 V [22,4 V]	10,5 V-12,0 V in Schritten von 0,1 V	12,6 V [25,2 V]	12,0V-13,5V in Schritten von 0,1 V
b04	12 V LiFePO4	12,8 V	14,2 V	13,35 V	11,2 V	10,5 V-12,0 V in Schritten von 0,1 V	12,6 V [25,2 V]	12,0 V-13,5 V in Schritten von 0,1 V
b05	24V LiFePO4	25.6V	28.4V	26.7V	22.4V	21.0V-24.0V in Schritten von 0.1V	25.2V	24.0V-27.0 V in Schritten von 0.1 V

***Die Regler verfügen nicht über einen ferngesteuerten Ein-/Ausgang. Daher dürfen nur LiFePO4 Batterien mit integriertem BMS verwendet werden (z. B. Victron SuperPack Batterien).**

Bei erneutem Betätigen der Taste MENU  gelangen Sie zu folgenden Einstellungen:



Spannung schwach - abschalten
Die Werkseinstellung ist 11,2 V [22,4 V].

Bei erneutem Betätigen der Taste MENU  gelangen Sie zu folgenden Einstellungen:



Erneutes Verbinden nach schwacher Spannung
Die Werkseinstellung ist 12,6 V [25,2 V].



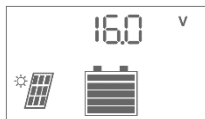

Anzeigebildschirm PV-Spannung: PV-Spannung und Ladezustand der Batterie.

Durch Betätigen der Taste MENU  gelangen Sie zum nächsten Bildschirm.



Anzeigebildschirm Ladestrom: Strom PV zu Batterie und Ladezustand der Batterie.

Durch Betätigen der Taste MENU  gelangen Sie zum nächsten Bildschirm.



Einstellungen Lastausgang

Die Werkseinstellung ist 24 h (Lastausgang ist immer an).

Ändern der Einstellungen Lastausgang

Halten Sie die Taste MENU  einige Sekunden lang gedrückt, bis die Zahl zu blinken beginnt.

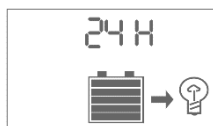

Einstellung Lastausgang

Siehe Tabelle unten.

H	Die Last kann durch den  Last ein/aus Schalter ein- und ausgeschaltet werden.
L	Last D2D Die Last wird bei Sonnenuntergang ein- und bei Sonnenaufgang ausgeschaltet.
L01-L23	Die Last wird nach Sonnenuntergang eingeschaltet und nach 1-23 Stunden ausgeschaltet.
24 H	Der BlueSolar Lade-Regler versorgt die Last ständig mit Energie.

Durch Betätigen der Taste MENU  gelangen Sie zum nächsten Bildschirm. (Hinweis: Phoenix VE.Direct Wechselrichter können gesteuert werden, indem der Lastausgang an den linken Anschluss der Fernsteuerung angeschlossen wird.)



Auslöseschwellwerte

Ist der BlueSolar Lade-Regler auf L01-L023 eingestellt, wird die Spannung des Solarmoduls gemessen, um zu entscheiden, ob es Nacht oder Tag ist, um die Last entsprechend ein- oder auszuschalten.

Die Werkseinstellung ist 4 A.

Durch Betätigen der Taste MENU  gelangen Sie zum nächsten Bildschirm.

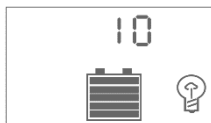

Verzögerungszeit für das Auslösen

Misst der BlueSolar Lade-Regler einen Spannungswert eines Solarmoduls unterhalb des Auslösewerts, wartet er 10 Sekunden lang und misst erneut, um sicherzugehen, dass die Nacht anbricht.

Fabrikeinstellung: 10 Sekunden

Durch Betätigen der Taste MENU  gelangen Sie zum nächsten Bildschirm.



Einstellungen Kurzschluss-Schutz

Einige induktive oder kapazitive Lasten lösen beim Einschalten den Kurzschluss-Schutz aus. Daher lässt sich der Kurzschluss-Schutz (SC) manuell deaktivieren. Sc.F = AUS, Sc.n = EIN. Standardeinstellung ist EIN



Anzeigebildschirm Entladestrom: Last-Strom und Batteriekapazität

Durch Betätigen der Taste MENU  gelangen Sie zum nächsten Bildschirm.



Anzeigebildschirm USB-Spannung: USB-Spannung

5 V (2 A max.)

Durch Betätigen der Taste MENU  gelangen Sie zum nächsten Bildschirm.



Interner Temperatur-Regler Wird der BlueSolar Lade-Regler beim Betrieb heiß, schaltet er sich ab und wartet, bis er auf Normaltemperatur heruntergekühlt ist. Dann nimmt er den Betrieb wieder auf.

Durch Betätigen der Taste MENU  gelangen Sie zum Haupt-Bildschirm.



5. Alarme

EN

NL

FR

DE

ES

SV

IT

Appendix



Hohe Temperatur

Bei einer Temperatur $\geq 85^{\circ}\text{C}$ schaltet sich der BlueSolar Lade-Regler in die erste Schutzphase: Er verringert den PV-Eingangsstrom, um die Temperatur zu senken. Es erscheint kein Alarm auf dem LCD-Display.

Bei einer Temperatur $>90^{\circ}\text{C}$ schaltet sich der BlueSolar Lade-Regler in die zweite Schutzphase: Der PV-Eingangsstrom wird auf null heruntergeregelt, der Lastausgang wird abgeschaltet und auf dem LCD-Bildschirm erscheint ein Alarmsymbol hohe Temperatur.

Nachdem die Temperatur wieder auf unter 82°C gesunken ist, nimmt der BlueSolar Lade-Regler seinen normalen Betrieb wieder auf.

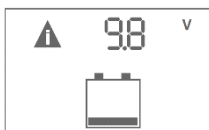

Niedrige Batteriespannung

Ist die Batterie auf weniger als den Spannungswert für das Abschalten aufgrund schwacher Spannung (LVD) entladen, schaltet der BlueSolar Lade-Regler den Lastausgang ab. Nach dem übermäßigen Entladen wird der Lastausgang wieder aktiviert, wenn die Batteriespannung den Schwellwert für das erneute Anschließen nach schwacher Spannung (LVR) erreicht hat.

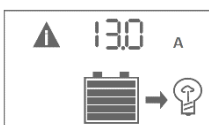

Überstrom-Schutz

Ein Überstrom am Lastausgang oder ein Kurzschluss wird durch das Blinken des Last-Symbols angezeigt. Der BlueSolar Lade-Regler deaktiviert den Lastausgang und versucht ihn nach 30 Sekunden wieder einzuschalten. Abschalten nach 60 s bei einer Last von 110 %-130 %
Abschalten nach 5 s bei einer Last von -130 %-160 %

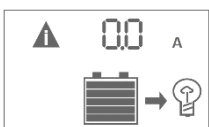

Kurzschluss-Schutz

Diese Anzeige bedeutet, dass sich der Kurzschluss-Schutz eingeschaltet hat. Der BlueSolar Lade-Regler schaltet den Lastausgang aus und wartet 30 Sekunden lang, bevor er versucht, neu zu starten. Der Nutzer sollte die Ursache überprüfen und rechtzeitig beheben.

6. Technische Daten

BlueSolar Lade-Regler	12 V 24 V 5 A		12 V 24 V 10 A		12 V 24 V 20A	
	12 V	24 V	12 V	24 V	12 V	24 V
Batteriespannung	12/24 V automatische Wahl					
Lade- & Last-Strom	5 A		10 A		20 A	
Lade-Modus	PWM, Zeit- und Beleuchtungsregelung					
Automatische Lastabschaltung	Ja					
Maximale Solaranlagen-Spannung	55V					
Solarspannungsbereich	15-28 V [30-55 V] ²					
Eigenverbrauch	<10mA					
Schutz	Verpolarter Anschluss der Solarmodule Verpolarter Anschluss der Batterie Niedrige Spannung - abschalten 130 % Last: Schaltet nach 60 s ab. 160 % Last: Schaltet nach 5 s ab. Kurzschluss: sofortiges Abschalten Überhitzungsschutz					
Solarmodul						
Empfohlene Solarmodul-Anlage	36 Zellen [72 Zellen] ²					
Max. Solar-Eingangsleistung	60 W	120 W	120 W	240 W	240 W	480 W
USB-Ausgänge						
Spannung	5 V					
Strom	2 A (gesamt von 2 USB-Ausgängen)					
Standardeinstellungen						
Konstantspannungsphase (b01) ¹	14,4 V [28,8 V] ²					
Erhaltungsladungsphase (b01) ¹	13,7 V [27,4 V] ²					
Last abschalten (b01) ¹	11,2 V [22,4 V] ²					
Last wieder einschalten (b01) ¹	12,6 V [25,2 V] ²					
Gehäuse						
Klemmengröße	6 mm ² / AWG10					
Gewicht	150 g					
Maße (HxBxT)	96 x 169 x 36 mm					
Montage	Vertikale Wandmontage, nur im Innenbereich					
Feuchte (nicht kondensierend)	Max. 95 %					
Betriebstemperatur	-35°C bis +60°C (volle Last)					
Kühlung	Naturkonvektion					
Schutzklasse	IP20					
Normen						
Sicherheit	EN60335-1, IEC62109-1					
EMC	EN61000-6-1, EN61000-6-3					

¹ Siehe auch 3.1 Einstellung Batterietyp.

² [V] Werte für 24 V System



1. Información general

IMPORTANTE

- **Conecte siempre la batería en primer lugar para que el controlador reconozca la tensión del sistema.**
- **Utilice paneles solares de 12V (36 celdas) para sistemas de 12V.**
- **Utilice paneles solares de 24V (72 celdas) para sistemas de 24V.**

La serie de controladores de carga BlueSolar utiliza el control de tensión de carga mediante modulación por ancho de pulsos (PWM, por sus siglas en inglés) combinado con un algoritmo de control multietapas.

2. Características

- Carga de las baterías de tres etapas [inicial, absorción y flotación].
- Tipo de batería: Plomo-ácido y LiFePO4 (con BMS interno)
- Protegido contra sobrecorriente.
- Protegido contra cortocircuitos.
- Protegido contra la polaridad inversa de los paneles solares y/o de la batería.
- Desconexión de las cargas consumidoras por baja tensión.
- Protección térmica.

3. Instalación

Nota importante: conecte siempre las baterías en primer lugar.



1. Conecte la batería - positivo y negativo.
2. Conecte las placas solares - positivo y negativo.
3. Conecte la carga consumidora - positivo y negativo.

A la hora de desinstalar, siga estos pasos a la inversa.

¡Si la secuencia no se hace en este orden el controlador de carga BlueSolar podría quedar dañado!

- 1.
2. Al realizar la primera instalación, asegúrese de que la batería está cargada para que el controlador de carga BlueSolar pueda reconocer el tipo de batería.
3. El cable de la batería debería ser lo más corto posible para minimizar pérdidas.
4. El controlador sólo es adecuado para baterías de plomo-ácido y LiFePO₄.
5. El controlador de carga BlueSolar sólo es adecuado para la regulación de módulos solares. Nunca conecte otra fuente de carga al controlador de carga BlueSolar.
- 6.

4. PANTALLA LCD y CONFIGURACIÓN

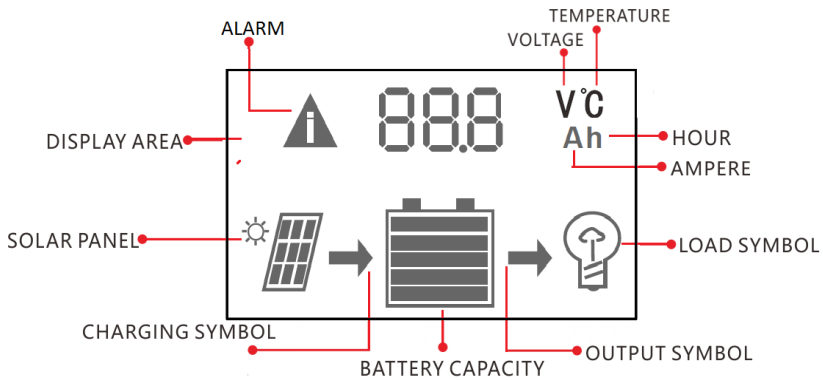

MENU : salte entre las distintas pantallas, o introduzca/modifique ajustes manteniendo pulsado.



UP (arriba) : pulse para cambiar los ajustes cuando esté en modo configuración.



DOWN (abajo) : pulse para cambiar los ajustes cuando esté en modo configuración.

Botón on/off de la carga consumidora cuando está en modo H.

EN

NL

FR

DE

ES

SV

IT

Appendix

4.1 Monitorización y configuración.

Los valores entre [] corresponden a las baterías de 24V





Pantalla de arranque. Tras conectar la batería la pantalla muestra el modelo de cargador solar y la tensión del sistema reconocidos por el cargador solar.

105=Controlador de carga BlueSolar – LCD – USB 12V|5A
 205=Controlador de carga BlueSolar – LCD – USB 24V|5A
 110=Controlador de carga BlueSolar – LCD – USB 12V|10A
 210=Controlador de carga BlueSolar – LCD – USB 24V|10A
 120=Controlador de carga BlueSolar – LCD – USB 12V|20A
 220=Controlador de carga BlueSolar – LCD – USB 24V|20A
 Pulse MENU  para entrar en la siguiente pantalla.



Pantalla principal: tensión de la batería, estado de la carga de la batería, y estatus de carga y descarga.

Pulse MENU  para entrar en la siguiente pantalla.

Modificar ajustes en la pantalla principal. Pulse el botón MENU  durante varios segundos hasta que la pantalla parpadee y podrá hacer modificaciones en:



Ajuste del tipo de batería.
Ver tabla más abajo.

El ajuste de fábrica es b01

	Tipo de batería	Tensión de la batería	Tensión de absorción	Tensión de flotación	Ajuste de fábrica de desconexión por tensión baja	Rango de desconexión Por tensión baja	Ajuste de fábrica de reconexión por tensión baja	Rango de reconexión por tensión baja
b01	PLOMO-ÁCIDO [AGM]	12,0V [24V]	14,4V [28,8V]	13,7V [27,4V]	11,2V [22,4V]	10,5V-12,0V en pasos de 0,1V	12,6V [25,2V]	12,0V-13,5V en pasos de 0,1V
b02	PLOMO-ÁCIDO [Gel]	12,0V [24V]	14,2V [28,4V]	13,7V [27,4V]	11,2V [22,4V]	10,5V-12,0V en pasos de 0,1V	12,6V [25,2V]	12,0V-13,5V en pasos de 0,1V
b03	PLOMO-ÁCIDO [Húmeda]	12,0V [24V]	14,6V [29,2V]	13,7V [27,4V]	11,2V [22,4V]	10,5V-12,0V en pasos de 0,1V	12,6V [25,2V]	12,0V-13,5V en pasos de 0,1V
b04	12V LiFePO4	12,8V	14,2V	13,35V	11,2V	10,5V-12,0V en pasos de 0,1V	12,6V [25,2V]	12,0V-13,5V en pasos de 0,1V
B05	24V LiFePO4	25,6V	28,4V	26,7V	22,4V	21,0V-24,0V en pasos de 0,1V	25,2V	24,0V-27,0V en pasos de 0,1V

*Los controladores no disponen de entrada on/off remoto. Por lo tanto, utilice solo baterías LiFePO4 con BMS integrado (como las baterías SuperPack de Victron)



victron energy

Pulse de nuevo en el botón MENU  y podrá hacer modificaciones en:

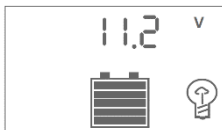

Desconexión por baja tensión

El ajuste de fábrica es 11,2V [22,4V]

Pulse de nuevo en el botón MENU  y podrá hacer modificaciones:



Reconexión por tensión baja

El ajuste de fábrica es 12,6V [25,2V]



Pantalla de tensión FV: Tensión FV y estado de la carga de la batería.

Pulse MENU  para entrar en la siguiente pantalla.



Pantalla de corriente de carga: Corriente del FV a la batería y estado de la carga de la misma.

Pulse MENU  para entrar en la siguiente pantalla.



Ajuste de la salida de cargas consumidoras.

El ajuste de fábrica es 24h (salida de carga siempre activada)

Cambiar los ajustes de la salida de cargas consumidoras.

Pulse el botón MENU  durante varios segundos hasta que el número parpadee:

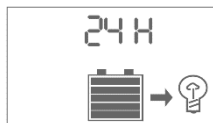

Ajuste de la salida de cargas consumidoras.

Ver tabla más abajo.

H	Las cargas consumidoras puede activarse o desactivarse con el  Interruptor de encendido/apagado de las cargas consumidoras.
L	Cargas consumidoras D2D Las cargas consumidoras se activarán al anochecer y se desactivarán al amanecer.
L01-L23	La salida de cargas consumidoras se activará después del anochecer y se desactivará tras 1-23 horas.
24H	El controlador de carga BlueSolar suministrará energía a las cargas consumidoras continuamente.

EN

NL

FR

DE

ES

SV

IT

Appendix

Pulse MENU  para entrar en la siguiente pantalla.
(Nota: los inversores Phoenix VE.Direct pueden controlarse conectando la conexión del lado izquierdo del control remoto a la salida de carga)



Nivel de activación

Cuando el controlador de carga se ajusta en L01-L23, medirá la tensión del panel solar para decidir si es de noche o de día para activar o desactivar las cargas consumidoras. El ajuste de fábrica es 4A.

Pulse MENU  para entrar en la siguiente pantalla.



Demora de la activación

Si el controlador de carga mide la tensión del panel solar y esta se encuentra por debajo del valor de activación, demorará la activación 10 segundos antes de volver a medirla para asegurarse de que ha anochecido.

Ajuste de fábrica: 10 segundos

Pulse MENU  para entrar en la siguiente pantalla.



Ajuste de la protección contra cortocircuitos.

Algunas cargas consumidoras inductivas o capacitivas activarán la protección contra cortocircuitos durante el arranque. Por este motivo, esta protección puede desactivarse manualmente. Sc.F = OFF, Sc.n = ON. El ajuste de fábrica es ON.



Pantalla de corriente de descarga: corriente de las cargas consumidoras y capacidad de la batería.

Pulse MENU  para entrar en la siguiente pantalla.



Pantalla de la tensión USB: Tensión USB 5V (2A máx.)

Pulse MENU  para entrar en la siguiente pantalla.



Temperatura interna del controlador. Si el controlador de carga se calentara durante su funcionamiento, se desactivará y esperará a que la temperatura caiga a un valor normal para volver a activarse.

Pulse MENU  para entrar en la pantalla principal.



5. Alarmas

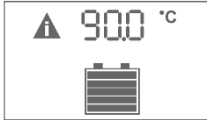

Temperatura alta

Cuando la temperatura sea $\geq 85^{\circ}\text{C}$, el controlador de carga se pondrá en la primera fase de protección: bajará la corriente de entrada FV para bajar la temperatura. La pantalla LCD no muestra ninguna alarma.

Cuando la temperatura sea $>90^{\circ}\text{C}$, el controlador de carga se pondrá en la segunda fase de protección: la corriente de entrada FV se reducirá a cero, la salida de cargas consumidoras se desactivará y en la pantalla LCD aparecerá el icono de alarma por temperatura alta.

Una vez la temperatura haya bajado de los 82°C , el controlador de carga BlueSolar continuará con su funcionamiento normal.

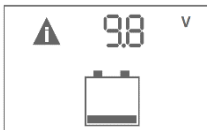

Tensión baja de la batería

Cuando la batería se descargue por debajo de la tensión de desconexión por tensión baja (LVD, por sus siglas en inglés), el controlador de carga BlueSolar desactivará la salida de cargas consumidoras. Tras una descarga excesiva, la salida de cargas consumidoras se reactivará cuando la tensión de la batería alcance el nivel de reconexión por tensión baja (LVR, por sus siglas en inglés).

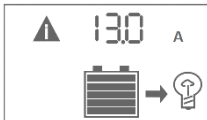

Protección de sobrecorriente.

La sobrecorriente en la salida de cargas consumidoras o el cortocircuito se indican mediante un icono de cargas consumidoras parpadeante. El controlador de carga BlueSolar desactivará la salida de cargas consumidoras e intentará reactivarla pasados 30 segundos.

Desconexión tras 60 s al alcanzar el 110%-130% de carga
Desconexión tras 5 s al alcanzar el 130%-160% de carga

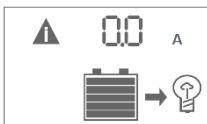

Protección contra cortocircuitos

Esta pantalla aparece cuando se produce un cortocircuito. El controlador de carga BlueSolar desconectará la salida de cargas consumidoras y esperará 30 s antes de intentar reiniciarla. El usuario deberá comprobar cuál es el problema y resolverlo a tiempo.

6. Especificaciones

Controlador de carga BlueSolar	12V 24V 5A		12V 24V 10A		12V 24V 20A	
	12V	24V	12V	24V	12V	24V
Tensión de la batería	Selección automática 12/24V					
Corriente de carga y cargas consumidoras	5A		10A		20A	
Modo de carga	PWM, Tiempo y Control de luminosidad					
Desconexión automática de la carga	Si					
Tensión FV máxima	55V					
Rango de tensión FV	15-28V [30-55V] ²					
Autoconsumo	<10mA					
Protecciones	Polaridad inversa de los paneles solares. Polaridad inversa de la batería. Desconexión por baja tensión. 130% de carga: Desconexión tras 60 segundos. 160% de carga: Desconexión tras 5 segundos. Desconexión inmediata en caso de cortocircuito. Protección de sobrecalentamiento					
Panel solar						
Paneles solares recomendados	36 celdas [72celdas] ²					
Potencia de entrada solar máxima	60W	120W	120W	240W	240W	480W
Salidas USB						
Tensión	5V					
Corriente	2A (total de 2 salidas USB)					
Valores predeterminados						
Carga de absorción (b01) ¹	14,4V [28,8V] ²					
Carga de flotación (b01) ¹	13,7V [27,4V] ²					
Desconexión de las cargas consumidoras (b01) ¹	11,2V [22,4V] ²					
Reconexión de las cargas consumidoras (b01) ¹	12,6V [25,2V] ²					
Carcasa						
Tamaño de los terminales	6mm ² / AWG10					
Peso	150 gr					
Dimensiones (al x an x p)	96 x 169 x 36 mm					
Montaje	Montaje vertical de pared, solo interiores					
Humedad (sin condensación)	Max. 95%					
Temperatura de trabajo	-35°C a +60°C (carga completa)					
Refrigeración	Convección natural					
Clase de protección	IP20					
Normativas						
Seguridad	EN60335-1, IEC62109-1					
EMC	EN61000-6-1, EN61000-6-3					

¹ Ver también 3.1 Ajuste tipo de batería.

² [V] valores para sistemas de 24V.



1. Allmän information

VIKTIGT

- **Anslut alltid batteriet först så att kontrollern kan detektera systemspänningen.**
- **Använd en 12 V (36 celler) solpanel i ett 12 V system.**
- **Använd en 24V (72 celler) solpanel i ett 24V system.**

Laddningsregulatorn BlueSolar använder pulsbreddsmodulerad (PWM efter engelskans Pulse Width Modulation) laddningsspänningskontroll tillsammans med en laddningskontrollsalgoritm i flera steg.

2. Funktioner

- Batteriladdning i tre steg (bulk, absorption och float).
- Batterityp Blysyra och LiFePO4 (med intern BMS)
- Skyddad mot överström.
- Skyddad mot kortslutning.
- Skydd mot omvänd polaritet vid anslutning till solcellspaneler och/eller batteri.
- Belastningsbortkoppling vid låg spänning (LVD)
- Temperaturskydd.

3. Installation

Obs: anslut alltid batterierna först.

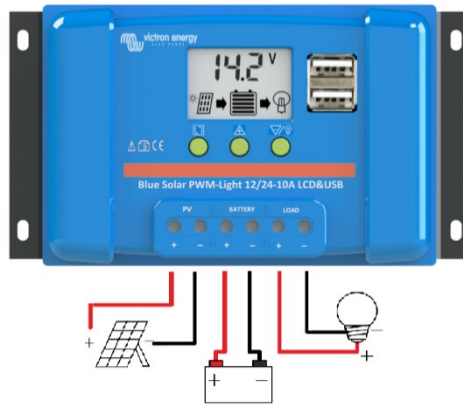

1. Anslut batteriet - plus och minus.
2. Anslut solcellspanelen - plus och minus.
3. Anslut belastningen - plus och minus.

Vid avinstallering gäller omvänd ordning.

En felaktig ordning kan skada laddningsregulatorn BlueSolar!

1. Säkerställ att batteriet är laddat så att laddningsregulatorn BlueSolar kan känna igen batteritypen innan den första installationen.
2. Batterikabeln bör vara så kort som möjligt för att minimera förluster.
3. Regulatorn passar endast till blysyrebatterier och LiFePO4-batterier.
4. Laddningsregulatorn BlueSolar är endast lämplig för att reglera solcellsmoduler. Anslut aldrig någon annan laddningskälla till laddningsregulatorn BlueSolar.

4. LCD-DISPLAY och INSTÄLLNINGAR

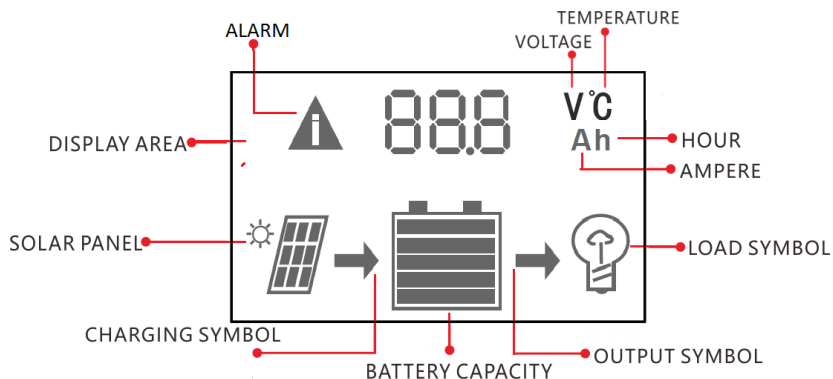

MENY: växla mellan olika displayer eller tryck ned länge för att gå in/ur inställningar.



UPP: tryck för att ändra inställningar när den är i inställningsläge.



NED: tryck för att ändra inställningar när den är i inställningsläge. Belastning av/på-knapp när den är i H-läge.

EN

NL

FR

DE

ES

SV

IT

Appendix

4.1 Övervakning och inställningar

Värden inom [] är för inställningar för 24 V-batterier.



Startdisplay. Efter att batteriet har anslutits visar skärmen vilken modell solcellsladdaren är samt vilken systemspänning laddaren känner av.

105=BlueSolar laddningsregulator – LCD – USB 12 V|5 A
205=BlueSolar laddningsregulator – LCD – USB 24V|5 A
110=BlueSolar laddningsregulator – LCD – USB 12 V|10A
210=BlueSolar laddningsregulator – LCD – USB 24V|10A
120=BlueSolar laddningsregulator – LCD – USB 12 V|20A
220=BlueSolar laddningsregulator – LCD – USB 24V|20A

Tryck på MENY  för att gå vidare till nästa display.



Huvuddisplay: batterispänning, laddningstillstånd batteri, laddnings- och urladdningsstatus.

Tryck på MENY för att gå vidare till nästa display.

Ändra inställningar i huvuddisplayen.

Tryck ned MENY -knappen i flera sekunder till displayen blinkar, du hamnar i:



Batteritypsinställning.

Se tabell nedan.

Fabriksinställningen är b01

	Batterityp	Batterispänning	Absorbtionsspänning	Floatspänning	Låg spänning frånkoppling fabriksinställning	Låg spänning frånkoppling intervall	Låg spänning återinkoppling fabriksinställning	Låg spänning återinkoppling intervall
b01	BLYSYRA [AGM]	12,0V [24V]	14,4V [28,8V]	13,7V [27,4V]	11,2V [22,4V]	10,5V-12,0V i steg av 0,1V	12,6V [25,2V]	12,0V-13,5V i steg av 0,1 V
b02	BLYSYRA [Gel]	12,0V [24V]	14,2V [28,4V]	13,7V [27,4V]	11,2V [22,4V]	10,5V-12,0V i steg av 0,1V	12,6V [25,2V]	12,0V-13,5V i steg av 0,1V
b03	BLYSYRA (Våt)	12,0V [24V]	14,6V [29,2V]	13,7V [27,4V]	11,2V [22,4V]	10,5V-12,0V i steg av 0,1V	12,6V [25,2V]	12,0V-13,5V i steg av 0,1V
b04	12V LiFePO4	12,8V	14,2V	13,35V	11,2V	10,5V-12,0V i steg av 0,1V	12,6V [25,2V]	12,0V-13,5V i steg av 0,1V
b05	24V LiFePO4	25,6V	28,4V	26,7V	22,4V	21,0V-24,0V i steg av 0,1V	25,2V	24,0V-27,0V i steg av 0,1V

*Regulatorerna har ingen fjärrstyrd på/av-ingång. Använd därför endast LiFePO4-batterier med integrerad BMS (som Victron SuperPack).



victron energy

Tryck återigen ner MENY--knappen och du hamnar i:

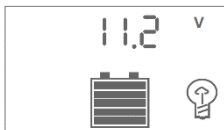

Låg spänning fränkoppling
Fabriksinställningen är 11,2 V [22,4 V]

Tryck återigen ner MENY--knappen och du hamnar i:

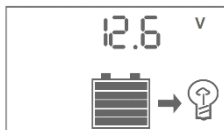

Låg spänning återinkoppling
Fabriksinställningen är 12,6V [25,2V]



Display för solcellsspänning: Solcellsspänning och batteriets laddningstillstånd.

Tryck på MENY  för att gå vidare till nästa display.



Display för laddningsström: Ström från solcell till batteri och batteriets laddningstillstånd.

Tryck på MENY  för att gå vidare till nästa display.



Inställningar för belastningsutgång.

Fabriksinställningen är 24 h (belastningsutgång alltid på)

Ändra inställningar för

belastningsutgång. Tryck ned MENY--knappen i flera sekunder till numret blinkar.

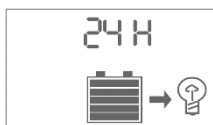

Inställningar för belastningsutgång.

Se tabell nedan.

H	Denna belastning kan kopplas på och ifrån via  av/på-brytaren för belastning.
L	Belastning D2D Belastningen kopplas på vid solnedgången och kopplas från vid soluppgången.
L01-L23	Belastningsutgången kopplas på efter solnedgången och kopplas ifrån efter 1-23 timmar.
24 tim	Laddningsregulatorn BlueSolar förser belastningen kontinuerligt med ström.

EN

NL

FR

DE

ES

SV

IT

Appendix

Tryck ned MENY -knappen för att gå vidare till nästa display
(Obs: Växelriktarna Phoenix VE.Direct kan styras genom att kopplas till anslutningen på vänster sida på fjärrkontrollen till belastningsutgången)



Utlösningsnivå

När laddningsregulatorn BlueSolar är inställd på L01 L23 kommer spänningen i solcellspanelen att mätas för att bestämma om det är natt eller dag för att koppla på eller ifrån belastningen. Fabriksinställningen är 4 V.

Tryck ned MENY -knappen för att gå vidare till nästa display



Fördröjningstid utlösning

När laddningsregulatorn BlueSolar mäter att solpanelsspänningen är under utlösningsnivån kommer den att vänta i 10 sekunder och sen mäta igen för att säkerställa att det börjar skymma. Fabriksinställning: 10 sekunder

Tryck ned MENY -knappen för att gå vidare till nästa display



Inställning för kortslutningsskydd.h

Vissa induktiva eller kapacitiva belastningar kommer att utlösa kortslutningsskyddet vid start. Därför kan skyddet avaktiveras manuellt. Sc.F = AV , Sc.n = PA. Standard är PA.



Display för urladdningsström: belastningsström och batterikapacitet.

Tryck på MENY  för att gå vidare till nästa display.



Display för USB-spänning: USB-spänning
5V (2A max)

Tryck på MENY  för att gå vidare till nästa display.



Regulatorns interntemperatur. Om laddningsregulatorn BlueSolar blir varm under drift kommer den att stängas av och vänta tills temperaturen har sjunkit ned till normal nivå och startar sedan om igen.

Tryck ned MENY -knappen för att komma till huvuddisplayen-



victron energy

5. Larm

EN

NL

FR

DE

ES

SV

IT

Appendix

Hög temperatur

När temperaturen är ≥ 85 °C, kommer laddningsregulatorn BlueSolar att gå in i första skyddsfasen, den kommer att sänka ingångsströmmen på solcellspanelen för att sänka temperaturen. LCD-displayen visar inte något larm.



När temperaturen är >90 °C, kommer laddningsregulatorn att gå in i andra skyddsfasen: ingångsströmmen för solcellspanelen kommer att sänkas till noll, belastningsutgången kommer att stängas av och ett larm om för hög temperatur visas på LCD-skärmen.

När temperaturen har sjunkit till under 82°C, laddningsregulatorn BlueSolar återupptar normal drift.

Låg batterispänning

När batteriet är urladdat till under fränkopplingsläget vid låg spänning (VD på engelska) kommer laddningsregulatorn BlueSolar att koppla från belastningsutgången. Efter överurladdning kommer belastningsutgången att kopplas på igen när batterispänningen når upp till nivån för återinkoppling vid låg ström (VR på engelska).

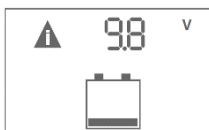

Skydd mot överström.

Överström eller kortslutning i belastningsutgången visas med en blinkande lastikon. Laddningsregulatorn BlueSolar kommer att koppla från belastningsutgången och försöka starta om den efter 30 sekunder.

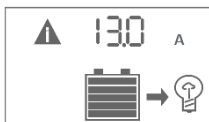

Stängs av efter 60 sek vid 110 %-130 % belastning.
Stängs av efter 5 sek vid -130 %-160 % belastning

Kortslutningsskydd

Den här displayen innebär att kortslutningsskyddet är aktiverat. Laddningsregulatorn BlueSolar kommer att koppla från belastningsutgången och vänta i 30 sekunder och därefter försöka starta om. Användaren bör kontrollera och få bort problemet i tid.

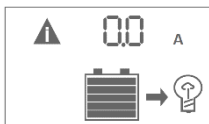

6. Specifikationer

Laddningsregulator Blue Solar	12V 24V 5A		12V 24V 10A		12V 24V 20A	
	12V	24V	12V	24V	12V	24V
Batterispänning	12/24 volt autoval					
Laddnings- och belastningsström	5m A		10A		20A	
Laddningsläge	PWM, tid- och ljuskontroll					
Automatisk fränkoppling av belastning	Ja					
Maximal solpanelsspänning	55V					
Solpanelsintervall	15-28 V [30-55 V] ²					
Egenkonsumtion	<10mA					
Skydd	Omvänd polaritetsanslutning av solcellspaneler. Omvänd polaritetsanslutning av batteriet. Fränkoppling vid läg spänning. 130 % belastning: Stänger av efter 60 sekunder. 160% belastning: Stänger av efter 5 sekunder. Kortslutning: omedelbar avstängning Skydd mot övertemperatur.					
Solcellspaneler						
Rekommenderad solcellspanel	36 cell [72 cell] ²					
Maximal solcellsgångsström	60W	120W	120W	240W	240W	480W
USB-utgångar						
Spänning	5V					
Ström	2 A (totalt från 2 USB-utgångar)					
Standardinställningar						
Absorptionsladdning (b01) ¹	14,4V [28,8V] ²					
Floatladdning (b01) ¹	13,7V [27,4V] ²					
Belastningsfränkoppling (b01)) ¹	11,2V [22,4V] ²					
Återinkoppling belastning (b01) ¹	12,6V [25,2V] ²					
Hölje						
Polstorlek	6mm ² / AWG10					
Vikt	150gr					
Dimension (h x b x d)	96 x 169 x 36 mm					
Montering	Montering på vertikal vägg, endast inomhus					
Fuktighet (ej kondenserande)	Max. 95%					
Drifttemperatur	-35°C till +60°C (full last)					
Kylning	Naturlig konvektion					
Skyddsklass	IP20					
Standarder						
Säkerhet	EN60335-1, IEC62109-1					
EMC	EN61000-6-1, EN61000-6-3					

¹ Se även 3.1 Batteritypsinställning.

² [V] värden för för 24 V-system



1. Informazioni Generali

IMPORTANTE

- **Connettere sempre prima la batteria, per consentire al regolatore di riconoscere la tensione del sistema**
- **Utilizzare un pannello solare da 12 V (36 celle) per un sistema da 12 V.**
- **Utilizzare un pannello solare da 24V (72 celle) per un sistema da 24V.**

I Regolatori di carica BlueSolar impiegano un controllo di tensione di carica con Modulazione di durata di impulso (PWM), in combinazione con un algoritmo di regolazione di carica multifase.

2. Caratteristiche

- Ricarica batteria in 3 fasi [prima fase di carica – assorbimento – mantenimento]
- Tipo di batteria: Piombo acido e LiFePO4 (con BMS interno)
- Protezione da sovracorrente.
- Protezione da cortocircuito.
- Protezione contro il collegamento con polarità inversa dei pannelli solari e/o della batteria.
- Tensione di disconnessione del carico.
- Protezione della temperatura

3. Installazione

Nota importante: collegare sempre prima la batteria.



1. Collegare i poli positivo e negativo della batteria.
2. Collegare i poli positivo e negativo del pannello solare.
3. Collegare i poli positivo e negativo del carico.

Per la disinstallazione si segue l'ordine inverso.

Un diverso ordine della sequenza può danneggiare il Regolatore di carica BlueSolar!

5. Assicurarsi che la batteria sia carica, per consentire al Regolatore di carica BlueSolar di riconoscere il tipo di batteria prima dell'installazione.
6. Il cavo della batteria deve essere il più corto possibile, per minimizzare le perdite.
7. Il regolatore è compatibile solo con batterie al piombo acido e LiFePO4.
8. Il Regolatore di carica BlueSolar è indicato solo per regolare i pannelli solari. Non collegare mai un'altra sorgente di carica al Regolatore di carica BlueSolar.

4. DISPLAY LCD e IMPOSTAZIONI

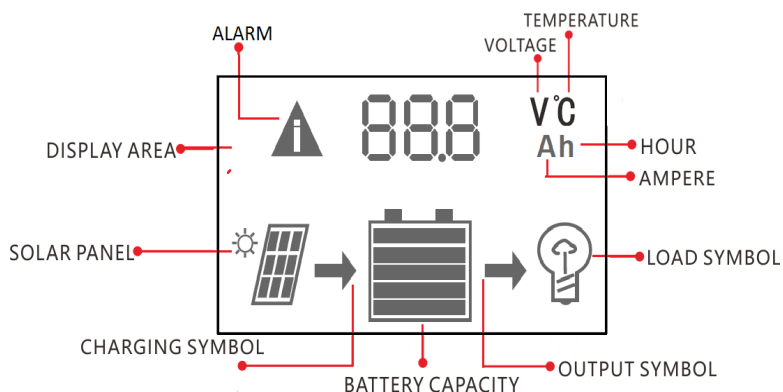

MENU: passare da un display all'altro o entrare/uscire dalle impostazioni premendolo a lungo.



UP: premerlo per cambiare le impostazioni quando ci si trova nella modalità di configurazione.



DOWN: premerlo per cambiare le impostazioni quando ci si trova nella modalità di configurazione.
Pulsante carico on/off quando ci si trova in modalità H.

EN

NL

FR

DE

ES

SV

IT

Appendix

4.1 Monitoraggio e impostazioni

I valori fra [] si riferiscono alle impostazioni di batterie da 24 V.



Display di Avvio. Dopo aver collegato la batteria, il display mostra il modello del caricabatterie solare e la tensione del sistema rilevata dal caricabatterie solare.

105=Regolatore di carica BlueSolar – LCD – USB 12V|5A
 205=Regolatore di carica BlueSolar – LCD – USB 24V|5A
 110=Regolatore di carica BlueSolar – LCD – USB 12V|10A
 210=Regolatore di carica BlueSolar – LCD – USB 24V|10A
 120=Regolatore di carica BlueSolar – LCD – USB 12V|20A
 220=Regolatore di carica BlueSolar – LCD – USB 24V|20A
 Premere MENU  per entrare nella seguente schermata.



Schermata principale: tensione batteria, stato di carica della batteria, stato di carica e di scarica.

Premere MENU  per entrare nella seguente schermata.

Modifica impostazioni nella Schermata principale.

Premere il pulsante MENU  per alcuni secondi, finché il display lampeggia e si entri in:



Impostazioni tipo di batteria. Vedere la tabella seguente.

L'impostazione di fabbrica è b01

	Tipo di batteria	Tensione batteria	Tensione di assorbimento	Tensione di mantenimento	Tensione bassa scollegare impostazioni di fabbrica	Tensione bassa scollegare campo	Tensione bassa ricollegare impostazioni di fabbrica	Tensione bassa ricollegare campo
b01	PIOMBO-ACIDO [AGM]	12.0V [24V]	14.4V [28,8V]	13.7V [27,4V]	11.2V [22,4V]	10.5V-12.0V ad intervalli di 0.1V	12.6V [25,2V]	12.0V-13.5V ad intervalli di 0.1V
b02	PIOMBO-ACIDO [Gel]	12.0V [24V]	14.2V [28,4V]	13.7V [27,4V]	11.2V [22,4V]	10.5V-12.0V ad intervalli di 0.1V	12.6V [25,2V]	12.0V-13.5V ad intervalli di 0.1V
b03	PIOMBO-ACIDO [Bagnato]	12.0V [24V]	14.6V [29,2V]	13.7V [27,4V]	11.2V [22,4V]	10.5V-12.0V ad intervalli di 0.1V	12.6V [25,2V]	12.0V-13.5V ad intervalli di 0.1V
b04	12V LiFePO4*	12,8V	14,2V	13,35V	11,2V	10.5V-12.0V ad intervalli di 0.1V	12,6V	12.0V-13.5V ad intervalli di 0.1V
b05	24V LiFePO4*	25,6V	28,4V	26,7V	22,4V	21.0V-24.0V ad intervalli di 0.1V	25,2V	24.0V-27.0V ad intervalli di 0.1V

*I regolatori non hanno un'entrata remota on/off. Pertanto, utilizzare solo batterie LiFePO4 con BMS integrato (come le batterie Victron SuperPack)



victron energy

Premere nuovamente il tasto MENU  e si entra in:

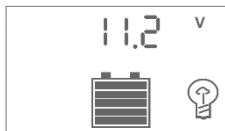

Disconnessione per bassa tensione

Le impostazioni di fabbrica sono 11,2V [22,4V]

Premere nuovamente il tasto MENU  e si entra in:

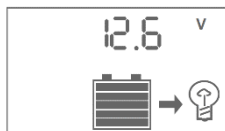

Riconnessione per bassa tensione

Le impostazioni di fabbrica sono 12,6V [25,2V]



Tensione FV mostra: La tensione FV e lo stato di carica della batteria.

Premere MENU  per entrare nella seguente schermata.



Corrente di carica mostra: La corrente da FV a batteria e lo stato di carica della batteria.

Premere MENU  per entrare nella seguente schermata.





Impostazioni uscita del carico.

Le impostazioni di fabbrica sono 24h (uscita del carico sempre attiva)

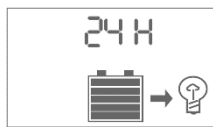
Impostazioni di modifica dell'uscita del carico. Premere il pulsante MENU  per alcuni secondi, finché i numeri lampeggino.



Impostazioni uscita del carico. Vedere la tabella seguente.

H	Il carico si può accendere/spegnere mediante l'interruttore Carico on/off.  
L	Carico D2D Il carico si accenderà al tramonto e si spegnerà all'alba.
L01-L23	L'uscita del carico si accenderà dopo il tramonto e si spegnerà dopo 1-23 ore.
24H	Il Regolatore di carica BlueSolar alimenterà ininterrottamente il carico.

Premere MENU  per entrare nella seguente schermata
(Nota: gli inverter Phoenix VE.Direct possono essere controllati collegando la connessione sulla sinistra del telecomando all'uscita del carico)



Livello attivazione

Quando il Regolatore di carica BlueSolar è impostato su L01-L23, si misurerà la tensione del pannello solare per decidere se è notte o giorno e accendere o spegnere il carico. Le impostazioni di fabbrica sono 4V.

Premere MENU  per entrare nella seguente schermata

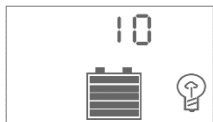

Attivazione tempo di ritardo

Quando il Regolatore di carica BlueSolar rileva una tensione del pannello solare inferiore al valore di attivazione, lo ritarderà per 10 secondi ed eseguirà una nuova misurazione per assicurarsi che sia di notte. Impostazioni di fabbrica: 10 sec.

Premere MENU  per entrare nella seguente schermata



Impostazioni protezione contro cortocircuito.

Alcuni carichi induttivi o capacitivi attiveranno la protezione contro il cortocircuito durante l'avvio. Pertanto, la protezione SC può essere disattivata manualmente. Sc.F = OFF, Sc.n = ON. Il predefinito è ON.

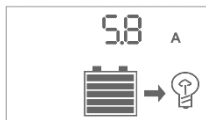

Corrente di scarica mostra: corrente del carico e capacità batteria.
Premere MENU  per entrare nella seguente schermata.



Tensione USB mostra: Tensione USB
5V (max 2A)

Premere MENU  per entrare nella seguente schermata.



Regolazione temperatura interna. Se il regolatore si surriscalda, si arresta ed attende che la temperatura torni a un livello normale, quindi si avvia nuovamente.

Premere MENU  per entrare nella Schermata principale.



5. Allarmi



Surriscaldamento

Quando $\text{temp} \geq 85^\circ\text{C}$, il regolatore entra nella prima fase di protezione: diminuisce la corrente di ingresso del FV per abbassare la temperatura. Sul display LCD non appaiono allarmi.

Quando $\text{temp} > 90^\circ\text{C}$, il regolatore entra nella seconda fase di protezione: riduce a zero la corrente di ingresso del FV, spegne l'uscita del carico e sul display LCD appare un'icona di allarme per alta temperatura.

Quando la temperatura scende sotto gli 82°C , il Regolatore di carica BlueSolar ritorna al funzionamento normale.

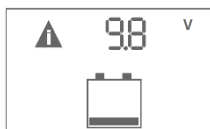

Bassa tensione batteria

Quando la batteria è più scarica della tensione di Disconnessione per bassa tensione (LVD), il regolatore disattiva l'uscita del carico. Dopo la sovrascarica, l'uscita del carico sarà riattivata quando la tensione della batteria arrivi al livello di Riconnesione per bassa tensione (LVR).

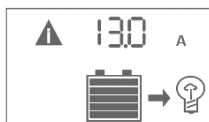

Protezione contro sovracorrente.

Una sovracorrente dell'uscita del carico o un cortocircuito sono indicati con un'icona del carico lampeggiante. Il regolatore disattiva l'uscita del carico e cerca di riattivarla dopo 30 secondi. Arresto dopo 60 sec in caso di carico al 110%-130%. Arresto dopo 60 sec in caso di carico al 130%-160%.

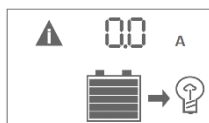

Protezione contro cortocircuito

Il Regolatore di carica BlueSolar disattiva l'uscita del carico, attende 30 sec e poi cerca di riattivarla. L'utente deve verificare ed eliminare il problema in tempo.

EN

NL

FR

DE

ES

SV

IT

Appendix

6. Specifiche

Regolatore di carica BlueSolar	12V 24V 5A		12V 24V 10A		12V 24V 20A	
	12V	24V	12V	24V	12V	24V
Tensione della batteria	12/24V con selezione automatica					
Corrente di Carica e del Carico	5A		10A		20A	
Modalità di carica	PWM, Controllo Tempo e Illuminazione					
Disconnessione automatica del carico	Sì					
Tensione massima pannello solare	55V					
Campo di tensione solare	15-28V [30-55V] ²					
Autoconsumo	<10mA					
Protezioni	Collegamento con polarità inversa dei pannelli solari. Collegamento con polarità inversa della batteria. Disconnessione per bassa tensione. Carico al 130%: Si arresta dopo 60 sec. Carico al 160%: Si arresta dopo 5 sec. Cortocircuito: arresto immediato. Protezione contro sovratemperatura.					
Pannello solare						
Pannelli solari raccomandati	36 celle [72 celle] ²					
Massima potenza solare di ingresso	60W	120W	120W	240W	240W	480W
Uscite USB						
Tensione	5V					
Corrente	2A (complessiva per le 2 uscite USB)					
Impostazioni di fabbrica						
Carica di assorbimento (b01)¹	14,4V [28,8V]					
Carica di mantenimento (b01)¹	13,7V [27,4V]					
Disconnessione del carico (b01)¹	11,2V [22,4V]					
Riconnessione del carico (b01)¹	12,6V [25,2V]					
Involucro						
Dimensione morsetto	6mm ² / AWG10					
Peso	150gr					
Dimensioni (a x l x p)	96 x 169 x 36 mm					
Montaggio	Supporto a muro verticale, solo per interni					
Umidità (senza condensa)	Max. 95%					
Temperatura di esercizio	da -35°C a +60°C (pieno carico)					
Raffreddamento	Convezione naturale					
Categoria di protezione	IP20					
Normative						
Sicurezza	EN60335-1, IEC62109-1					
Compatibilità elettromagnetica	EN61000-6-1, EN61000-6-3					

¹ Vedere anche 3.1 Impostazioni tipo di batteria.

² [V] valori per un sistema a 24V



7.

EN - Mechanical drawing.

NL - Mechanische tekening.

FR - Schémas mécaniques.

DE - Technische Zeichnung

ES - Dibujo mecánico.

SV - Mekanisk ritning.

IT - Disegni meccanici

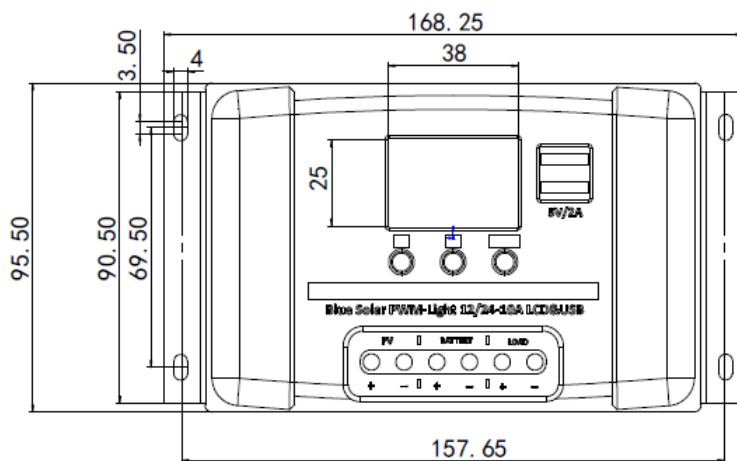

EN

NL

FR

DE

ES

SE

IT

Appendix

Victron Energy Blue Power

Distributor:

Serial number:

Version : 04

Date : February 4th, 2019

Victron Energy B.V.
De Paal 35 | 1351 JG Almere
PO Box 50016 | 1305 AA Almere | The Netherlands

General phone : +31 (0)36 535 97 00
E-mail : sales@victronenergy.com

www.victronenergy.com